

# Back2Back

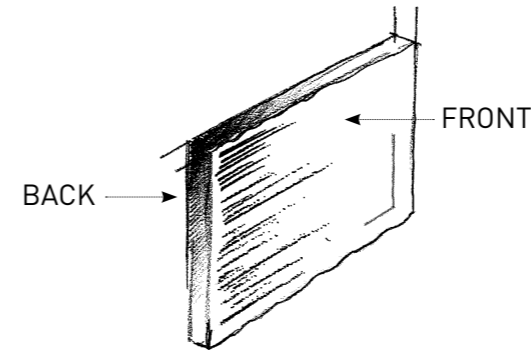



“... la pietra come musa ispiratrice...”

“... materiali versatili, superfici resistenti...”

“... una selezione di lastre per progettare...”

“... stone as muse and inspiration...”  
 “... versatile materials, tough surfaces...”  
 “... a selection of slabs for architectural projects...”

“... Stein als Inspiration...”  
 “... vielseitige Materialien, strapazierfähige Oberflächen...”  
 “... eine Auswahl von Platten für die Planung...”

“... la pierre devenue muse inspiratrice...”  
 “... des matériaux polyvalents, des surfaces résistantes...”  
 “... une sélection de plaques servant à la conception...”

“... la piedra como musa inspiradora...”  
 “... materiales versátiles, superficies resistentes...”  
 “... una selección de losas para proyectar...”

“... камень становится музой-вдохновительницей...”  
 “... универсальные материалы, прочные поверхности...”  
 “... ассортимент плит для создания проектов...”

# Back2Back

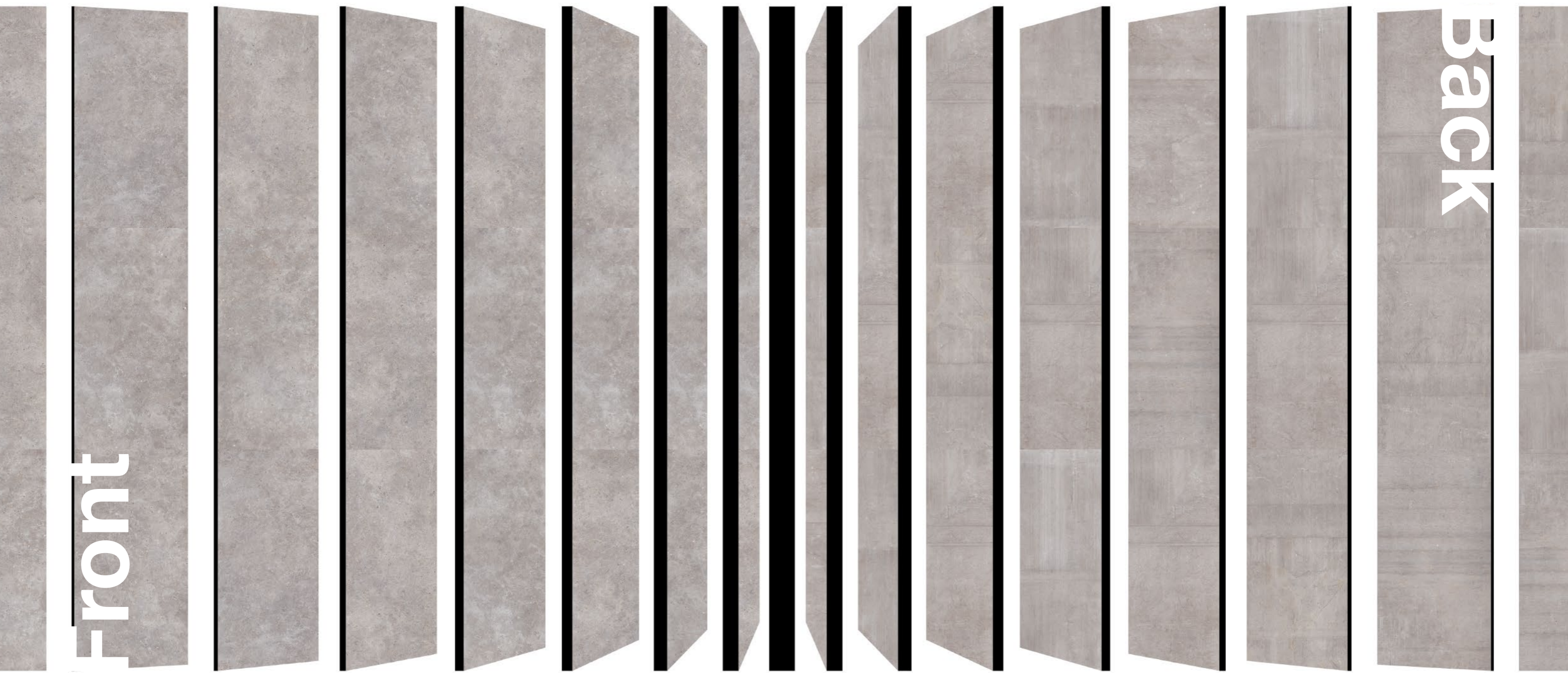

front

Back



# Back2Back Spaces

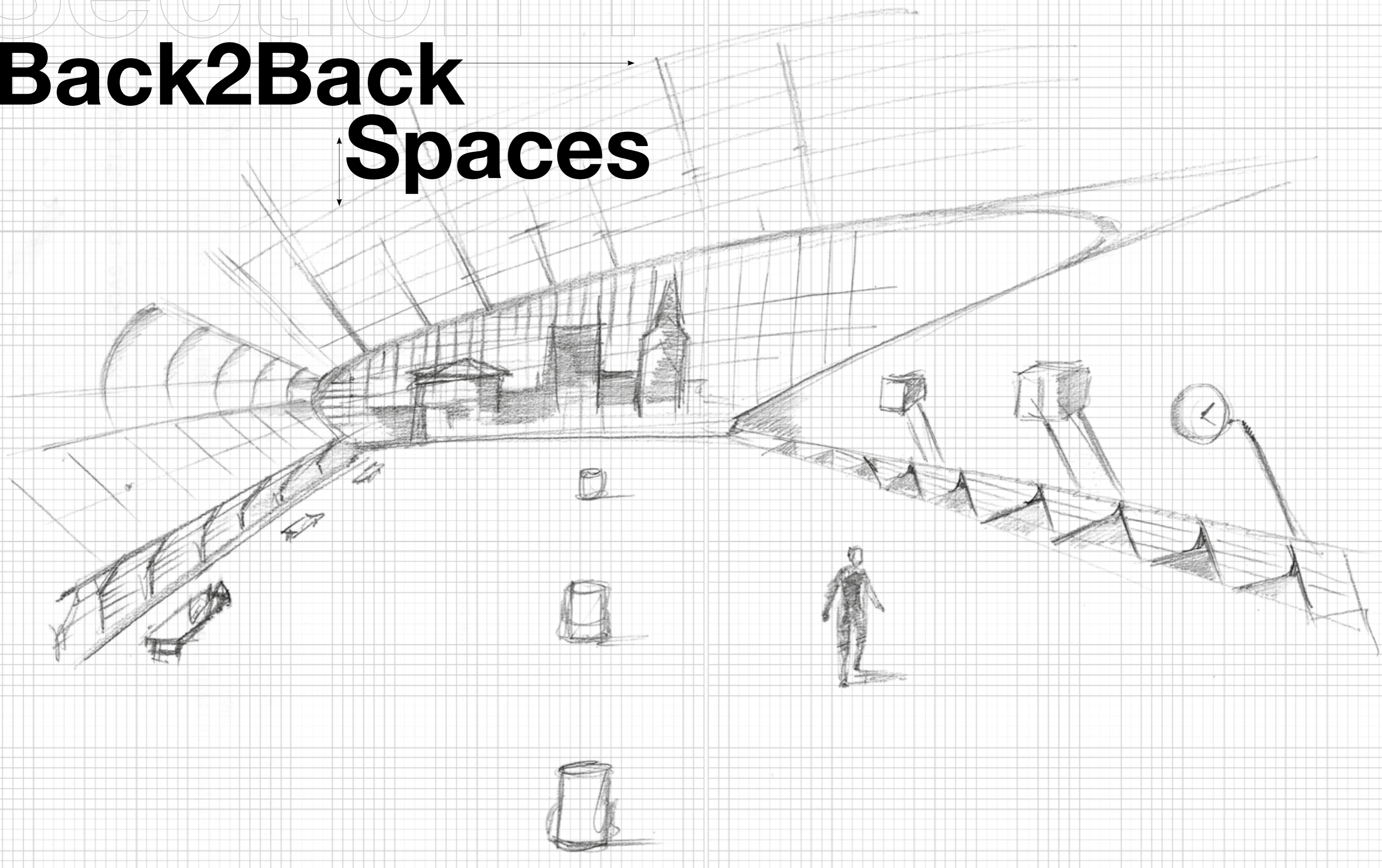

drevo

BACK GREY NAT. RETT.  
60x120 - 23<sup>5/8</sup>"x47<sup>1/4</sup>"

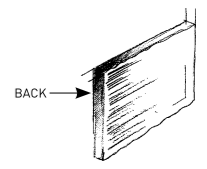

# g r o Back

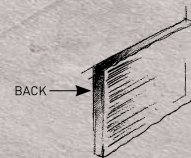

drevo

FRONT MINERAL GREY NAT. RETT.  
60x120 - 23<sup>5</sup>/<sub>8</sub>" x 47<sup>1</sup>/<sub>4</sub>"

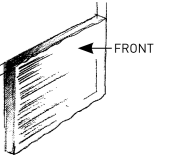

# Front natural

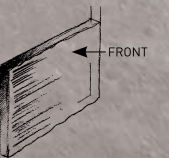



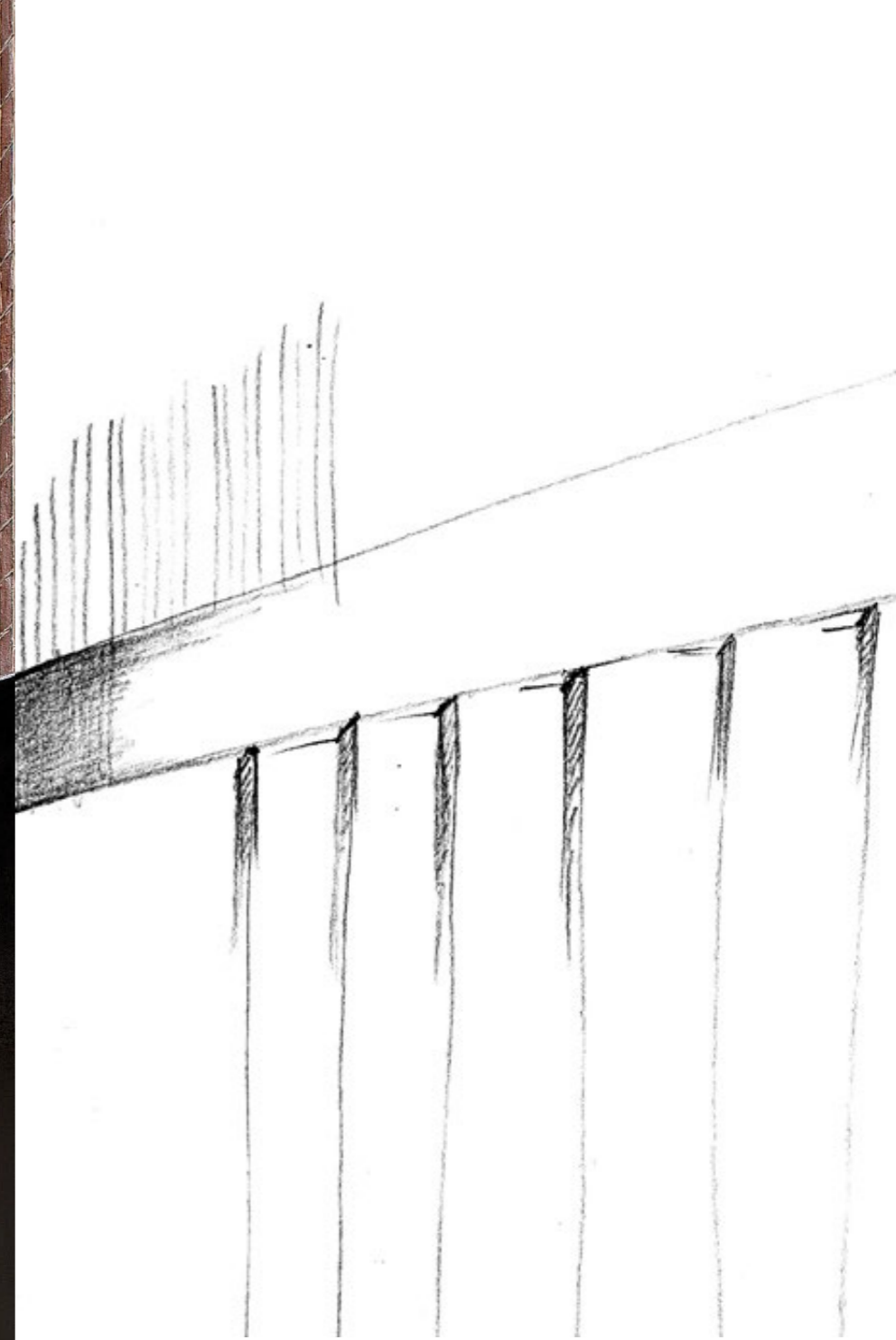

BACK GREY RETT.  
60x120 - 23<sup>5/8</sup>x47<sup>1/4</sup>"

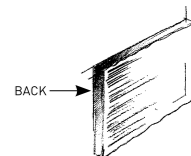



**Mineral Grey**  
Front

**Back Grey**  
Back

# Formati

SIZES / FORMATS / FORMATE / TAMAÑOS / ФОРМАТЫ

FRONT  9,5 mm.

BACK  9,5 mm.



**Naturale Rett.**  
60x120 - 23<sup>5/8</sup>"x47<sup>1/4</sup>"  
E72V Mineral Grey ● T31



**Naturale Rett.**  
60x120 - 23<sup>5/8</sup>"x47<sup>1/4</sup>"  
E72R Back Grey ● T31

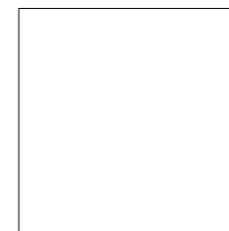

**Naturale Rett.**  
60x60 - 23<sup>5/8</sup>"x23<sup>5/8</sup>"  
E1U1 Mineral Grey ● T17

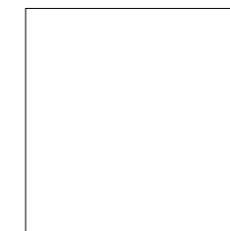

**Naturale Rett.**  
60x60 - 23<sup>5/8</sup>"x23<sup>5/8</sup>"  
E1TX Back Grey ● T17



**Naturale Rett.**  
30x60 - 11<sup>13/16</sup>"x23<sup>5/8</sup>"  
E1U5 Mineral Grey ● T14



**Naturale Rett.**  
30x60 - 11<sup>13/16</sup>"x23<sup>5/8</sup>"  
E1U3 Back Grey ● T14

# Decori

DECORS / DECORS / DEKORE / DECORADOS / ДЕКОРЫ

## MOSAICO BACK2BACK\*

Tessera - Chip 2,8x2,8 - 1<sup>1/8</sup>"x1<sup>1/8</sup>"



30x30 - 11<sup>13/16</sup>"x11<sup>13/16</sup>"

E1VE Grey Nat. ● A96







\* Su rete in fibra - On fibre mesh backing - Sur filet en fibre de verre  
Auf Glasfasernetz - Sobre malla de fibra - На волоконной сетке

Si consiglia la posa con fuga 2 mm. - Laying with a 2 mm-joint is recommended. - Pose recommandée avec joints de 2 mm.  
Es wird eine Fugenbreite von 2 mm empfohlen. - Se recomienda la colocación con juntas de 2 mm. - Рекомендуется укладка с швом 2 мм.

Verificare l'abbinamento dei toni tra i formati differenti. - Check the colour matching between different sizes.  
Vérifier l'assortiment des tonalités entre les différents formats. - Die Kombination der Farbtöne unter den verschiedenen Formaten prüfen.  
Comprobar la combinación de los tonos entre los distintos formatos. - Проверьте сочетание тонов у разных форматов.

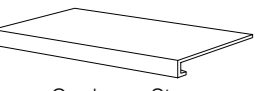
# Pezzi speciali

TRIMS / PIECES SPECIALES / FORMTEILE  
PIEZAS ESPECIALES / СПЕЦИАЛЬНЫЕ ИЗДЕЛИЯ

	Dimensione Size	Mineral Grey		Back Grey		Fascia di prezzo Price band
 Battiscopa - Skirting	Nat. Rett. 7x60 - 2 <sup>3/4</sup> "x23 <sup>5/8</sup> " Pcs. Box 15 - LM x Box 9,00	E1YJ		E1YC		● A11
 Gradino - Stair Tread	Nat. Rett. 33x60 - 12 <sup>15/16</sup> "x23 <sup>5/8</sup> " Pcs. Box 6 - LM x Box 3,60	E1Y8		E860		● A54
 Gradone - Step	Nat. Rett. 33x60x3,2x3,2 12 <sup>15/16</sup> "x23 <sup>5/8</sup> "x1 <sup>1/4</sup> "x1 <sup>1/4</sup> " Pcs. Box 4 - LM x Box 2,40	E85X		E85R		● A68
 Angolare Dx   Sx Corner Tile Dx   Sx	Nat. Rett. 33x33x3,2x3,2 12 <sup>15/16</sup> "x12 <sup>15/16</sup> "x1 <sup>1/4</sup> "x1 <sup>1/4</sup> " Pcs. Box 2 - LM x Box 0,66	DX E85M	SX E85N	-		● A72
 Angolare - Corner Tile	Nat. Rett. 33x33x3,2x3,2 12 <sup>15/16</sup> "x12 <sup>15/16</sup> "x1 <sup>1/4</sup> "x1 <sup>1/4</sup> " Pcs. Box 2 - LM x Box 0,66	-		E859		● A72
 Elemento a "L" L Shaped Piece	Nat. Rett. 15x60x4,5 5 <sup>7/8</sup> "x23 <sup>5/8</sup> "x1 <sup>3/4</sup> " Pcs. Box 4 - LM x Box 2,40	-		E1YK		● A34

# Back2Back

Dry - Pressed Ceramic Tiles ISO 13006 Annex G - UNI EN 14411 Annex G - Bla UGL



## CARATTERISTICHE TECNICHE

Technical Features - Caracteristiques Techniques - Technische Eigenschaften  
Technische Eigenschaften - Características Técnicas - Технические Характеристики

## NORMA

Standard - Norme  
Norm - Norma - Норма

## VALORI

Value - Valeur  
Vorgabe - Valor - Средние

	<b>ASSORBIMENTO D'ACQUA (VALORE MEDIO IN %)</b> Water absorption (Average value expressed in %) - Absorption d'eau (Valeur moyenne en %) - Wasseraufnahme (Durchschnittswert in %) - Absorción de agua (Valor medio en %) - Поглощение воды	UNI EN ISO 10545/3 ASTM C373	CONFORME COMPLIANT
	<b>RESISTENZA ALLA FLESSIONE</b> Modulus of rupture - Resistance a la flexion - Biegefestigkeit Resistencia a la flexion - Прочность на изгиб	SPESSORE UNI EN ISO 10545/4	<b>9,5 mm</b> ≥ 45 N/mm <sup>2</sup>
	<b>FORZA DI ROTTURA</b> Breaking strength - Résistance à la rupture - Bruchlast Resistencia a la rotura - Разрывное усилие	UNI EN ISO 10545/4 ASTM C648	≥ 2000 N 400 Lbs
	<b>RESISTENZA AL GELO</b> Frost resistance - Résistance au gel - Frostbeständigkeit Resistencia a las heladas - Морозостойкость	UNI EN ISO 10545/12 ASTM C1026	CONFORME UNAFFECTED
	<b>RESISTENZA CHIMICA</b> <b>AD ALTE E BASSE CONCENTRAZIONI DI ACIDI E BASI</b> Chemical resistance to high and low acid and basic concentrations Résistance chimique aux hautes et basses concentrations d'acides et de bases Chemikalienfestigkeit bei hohen und niedrigen Konzentrationen von Säuren und Basen Resistencia química con concentraciones altas y bajas de ácidos y bases Химическая стойкость к высоким и низким концентрациям кислот и щелочей	UNI EN ISO 10545/13 ASTM C-650	A - LA - HA UNAFFECTED
	<b>RESISTENZA ALLE MACCHIE</b> Stain resistance - Résistance aux taches - Fleckenbeständigkeit Resistencia a las manchas - Стойкость к образованию пятен	UNI EN ISO 10545/14	5
	<b>COEFFICIENTE DI ATTRITO</b> Slip resistance Coefficient de glissement Rutschfestigkeit Barfußbereich Coeficiente de atrito medio Коэффициент трения		<b>NAT.</b> DIN 51130 DGUV Regel 108-003 R10 DIN 51097 DGUV Information 207-006 B (A+B) ANSI A326.3:2017 DCOF WET ≥ 0,50 B.C.R.A. D.M. N. 236 14/6/89 ≥ 0,40 AS 4586-2013 Anexo A P2 BS 7976-2: 2002 BSEN13036-4:2011 < 36 Pendulum testers Moderate Slip potential UNE 41901:2017 EX DB SUA (actual) -

Per maggiori chiarimenti sui dati tecnici e sulla garanzia consultare il catalogo generale in vigore. - For further information on technical specifications, please consult our up-dated general catalogue. - Pour toutes informations supplémentaires sur les données techniques et sur les garanties, veuillez consulter le catalogue general en vigueur. - Für weitere Informationen über technische Daten und Garantie beziehen sie sich bitte auf den aktuellen Gesamtkatalog. - Para ultérieures informaciones sobre los datos técnicos y la garantía, vease el catalogo general en vigor. - Более подробную информацию о технических данных и гарантии смотрите в действующем сводном катал.



PRODUCT CERTIFIED  
FOR LOW CHEMICAL  
EMISSIONS:  
UL COMFEGG  
UL 2818



放射性水平A类



12%



## IMBALLI E PESI

Packing and Weight | Emballages et Poids | Verpackung und Gewicht | Embalajes y Pesos | Упаковка и Вес

Formato Size Format Format Тамаño Формат cm	Spessore Thickness Epaisseur Stärke Espesor Толщина mm	Pz. x Mq. Pieces x Sqm Pcs / M <sup>2</sup> Stk. x Qm Pzs x Mc. Шт x Кв.М.	Pz. x Scat. Pieces x Box Pcs / Bte Stk. x Krt. Pzs x Caja Шт x Кор.	Mq. x Scat. Sqm x Box M <sup>2</sup> / Bte Qm x Krt. Mc. x Caja Кв.М. x Кор.	Peso x Scat. Weight x Box Poids / Bte Gewicht x Krt. Peso x Caja Вес x Кор. Kg	Scat. x Pal. Boxes x Pal. Bte / Pal. Krt. x Pal. Cajas x Pal. Кор. x Подд.	Mq. x Pal. Sqm x Pal. M <sup>2</sup> / Pal. Qm x Pal. Mc. x Pal. Кв.М x Подд.	Peso x Pal. Weight x Pal. Poids / Pal. Gewicht x Pal. Peso x Pal. Вес x Подд. Kg
60x120 Naturale	9,5	1,39	2	1,44	31,68	36	51,84	1140
60x60 Naturale	9,5	2,78	3	1,08	23,76	40	43,20	950
30x60 Naturale	9,5	5,56	6	1,08	23,76	48	51,84	1140
30x30 Mosaico Naturale	9,5	11,11	5	0,45	8,73	60	27,00	524



**Back2Back**

The text "Back2Back" is rendered in a bold, black, sans-serif font. Each letter has a double outline, with the inner outline being solid black and the outer one being a thin white line. Above the text, there are two horizontal double-headed arrows. The first arrow spans the width of the first "Back" segment, and the second arrow spans the width of the second "Back" segment, indicating the width of each part of the text.



<b>Ergon is a brand of Emilceramica S.r.l. a socio unico</b>	<b>Sede Commerciale/ Amministrativa</b>
<a href="http://emilgroup.it/ergon">emilgroup.it/ergon</a> <a href="http://emilgroup.it">emilgroup.it</a>	Via Ghiarola Nuova, 29 - 41042 Fiorano Modenese (MO) Italy T +39 0536 835111 - <a href="mailto:info@emilceramicagroup.it">info@emilceramicagroup.it</a>